



TARSIUS Pole mounted

8750918

TARSIUS Pole mounted - 24 LED 3000K Street optic

Lighting information



Source power type	24 LED
Colour temperature	3000K
CRI	>80
MCADAMS	3
LM 80/TM-21	L90B10@>100Kh

Source power	50,00 W
Nominal flux	6000 lm

Plug-in power	54,00 W
Real flux	5770 lm
Maximum intensity	395 cd/klm
Beam angle	Street optic
Tilttable	

Power Supply Unit	220 ÷ 240V
Operating frequency	50/60 Hz
Power factor	0,98
Dimmable	DALI
Safety class	II
Luminaires of B16A MCB	Max 25
Inrush current	20A 270?s
Wiring	External
Cable section	2 x 0,75 mm ²
Cable section	2 x 1,00 mm ²
Cable length	8.000 mm;
Cable type	H05RN-F

Protection Rating	IP66
Breaking Strength	IK 10

Energy efficiency class	A/A+/A++
Diffuser type	Transparent methacrylate
Diffuser thickness	4 mm

Colours

Standard colour

● .06 Grey

Colours available on request

● .01 Black

○ .02 White

● .07 Corten

● .08 Anthracite

● .09 Bronze



Platek®

PLATEK s.r.l.
Via Paderno, 19 | 25050 Rodengo Saiano (BS) ITALY
P.IVA 03320290178 | Codice fiscale 03007130176
Registro delle Imprese di Brescia n. 03007130176 REA 311057
Capitale sociale Euro 1.000.000,00 i.v. Società con unico socio

Last update:04/02/2022

TARSIUS Pole mounted

Product features

Die-cast body and ange manufactured in aluminium alloy EN 44300 with very low copper content. As an alternative to the traditional polycarbonate (PC), used with diffusers to seal the lamp polymethylmethacrylate (PMMA) is used, so we obtain characteristics of high transparency, UV resistance and scratch resistance. High performance anodized aluminium reflector. A4 Stainless steel screws. GORE® valve to prevent condensing. Subjected to galvanic anodizing treatment divided into distinct phases: mechanical satin finishing, surface degreasing, anodic oxidation and final sealing. The product is painted following a continuous two step paint process (epoxy-based primer + polyester-based colour finish), which allows to generate a single thick protective coating which then generates a protective barrier against atmospheric agents and UV rays. Before fixing the diffuser on the Platek products a Pre-treatment using an atmospheric pressure plasma process is carried out on the surface. The process activates the ionic load on the surface exactly where it is needed, thus promoting the best silicone grip possible and removing any residual release of agents for a longer lasting seal. The next steps are the coating of silicone and the assembly of the diffuser on the lighting fixture, with an automated process to guarantee the perfect sealing of the lamp.

Technical dimensions

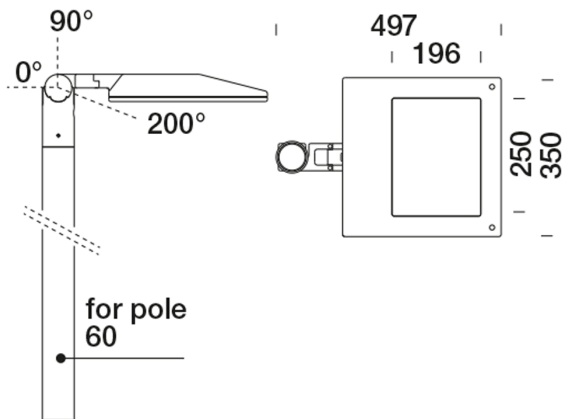

Technical shipping information

Net weight	6,00 kg
Gross weight	7,00 kg
Packaging width	750,00 mm
Packaging height	90,00 mm
Packaging depth	380,00 mm

8750918

TARSIUS Pole mounted - 24 LED 3000K Street optic

Lighting information

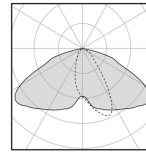

Plug-in power	54,00 W
Real flux	5770 lm
Maximum intensity	395 cd/klm
Beam angle	Street optic

Lighting Simulation



Street optics

simulation made with TARSIUS Pole mounted 54,0 W 3000K

Optics:	Street optic
Code:	8750918
Distance between products:	22 m
Height from wall:	6.0000 m

Plug-in power	54,00 W
Real flux	5770 lm
Maximum intensity	395 cd/klm
Beam angle	Street optic

Platek®

PLATEK s.r.l.
Via Paderno, 19 | 25050 Rodengo Saiano (BS) ITALY
P.IVA 03320290178 | Codice fiscale 03007130176
Registro delle Imprese di Brescia n. 03007130176 REA 311057
Capitale sociale Euro 1.000.000,00 i.v. Società con unico socio

Last update:04/02/2022



TARSIUS Pole mounted

8750918

TARSIUS Pole mounted - 24 LED 3000K Street optic

Mechanical accessories

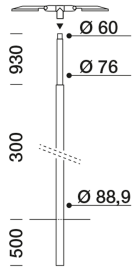

8650004
Ø 89/76 mm H. 4 m pole (Ø 60 mm connection) 0,5 m ground recessed

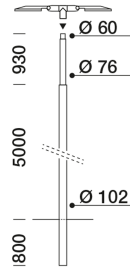

8650006
Ø 102/76 mm H. 6 m pole (Ø 60 mm connection) 0,8 m ground recessed

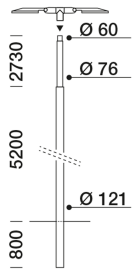

8650008
Ø 121/76 mm H. 8 m pole (Ø 60 mm connection) 0,8 m ground recessed

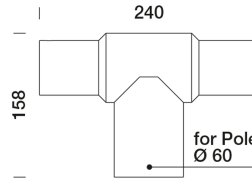

8650020
Ø 60 mm pole adaptor for two light fittings

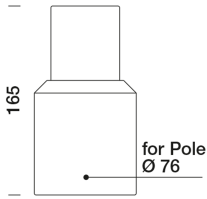

8650025
Ø 76 mm pole adaptor for single light fittings



TARSIUS Pole mounted

8750918

TARSIUS Pole mounted - 24 LED 3000K Street optic

The process of galvanisation and multi-coating protection

Platek goes well beyond the standards required for conventional protection processes, making use of its longstanding and in-depth expertise in aluminium alloys. All the aluminium components of the products - extruded, die-cast or turned - are subjected to a galvanic anodizing process in the phase following mechanical processing. The process increases their wear resistance and improves the adhesion of the paint. Galvanization involves three distinct phases: mechanical satin finishing and surface degreasing, anodic oxidation and fixing. After the first phase that eliminates any impurities, the aluminium body is immersed in special electrolytic tanks, in which the aluminium surface is transformed into aluminium oxide, which makes the metal more resistant. To respond optimally to the needs of the global market, all Platek products undergo a two-layer painting process. After preparation with washing and rinsing in accordance with the strictest environmental standards, the product is coated with an epoxy primer which guarantees, in addition to anodizing, an excellent degree of protection. The final step is the preparation of the polyester powder which gives the final velvety finish of the component. These last two phases, being done in a continuous cycle, form a single high-thickness layer that is resistant to the action of UV rays and atmospheric agents. This process allows corrosion resistance in salt fog that far exceeds the average standards of the market to be achieved.

The gluing process and plasma treatment

One of the most complex and delicate aspects in outdoor lighting products is the fitting of glass onto the lighting body. This must ensure over time an excellent degree of insulation from atmospheric agents, even in harsh environmental conditions, to maintain a stable performance with zero maintenance. The gluing process of the glass on Platek products is managed at an automated workstation, preceded by a pre-treatment of the surfaces with atmospheric pressure plasma. Pre-treatment modifies the characteristics and ionic properties of the treated surfaces, activates the polar materials at strategic points, removes any residue of detaching agents, such as silicones and oils with a precision microcleaning, favouring excellent wettability of the bonded surfaces and a stable seal in time. The gluing process of the glass with specific plasma treatment allows a bonding force four times greater than similar products to be obtained. The shaping of the surfaces is followed by the application of the silicone and the assembly of the glass onto the lighting body using an automated process that guarantees perfect sealing of the lamp.

Precise LED selection

All LEDs used by Platek, once assembled by trusted personnel are tested with suitable instruments to check the colour specification required by Platek standards. The choice of using only 3 McAdams colour steps and with a CRI value exceeding 90, provide a high level of light quality that is difficult to find in the world of outdoor lighting. As far as LED products are concerned, Platek has adopted a system of protection against electrostatic discharge along the entire production chain of electronic components to increase the resistance of circuits to power surges.